

Contents

1. Box Contents	
- MilkPal Machine	
- Instruction Manual	
- Milk Tube	
- Water Inlet & 90 form	
- Waste Pipe	
- Milk Screens	
2. Information	3
a. Introduction	
b. Safety	
c. Electrical Installation Procedure	
d. Plumbing Installation Procedure	
e. Hazards	
f. Technical Specification	
3. Counter Cut-out	6
4. Installation	7
a. Preparation	
b. Connecting to Fridge	
c. Connecting Milk Container	
5. Set up & Operation	10
a. Operating the system for the first time	
b. Main Interface	
c. Cleaning & Temperature	
d. Setting Recipes & Parameters	
i. Setting recipes	
ii. Changing Parameters	
e. Adding a New Recipe	
f. Setting Temperature	
6. Advanced Settings	18
7. Cleaning.....	21
a. Recommended Cleaning Solutions	
b. Cleaning Settings	
c. Daily Cleaning	
d. Blockage Cleaning	
8. Troubleshooting.....	26
a. Debugging the Milk Froth Production	
b. Water Dispensing Pre-Post Output	
c. Tube Pre-Filling	
d. Cold Pre-Emptying	
9. Contact	32

Information

Introduction

The information provided in this manual is intended to assist in the installation and maintenance of the appliance. Please read the instructions carefully to prevent accidents and ensure an efficient installation. This manual is not a substitute for any safety instructions or technical data affixed to the machine or its packaging. All information in this manual is current at the time of publication and is subject to change without notice. The company accepts no responsibility for any damage or injury caused by incorrect or unreasonable installation and operation.

Safety

When using electrical appliances, basic safety precautions should always be followed to prevent the risk of fire, electric shock, burns, or other injuries or damages.

- Read all operating and safety instructions carefully.
- This appliance is suitable for indoor use only.
- This appliance must be placed/installed on a horizontal flat stable surface.
- The ambient temperatures this appliance should operate within are 5 °C – 35 °C (41°F–95°F).
- Do not store the appliance in ambient temperature lower than 5 °C (41°F).
- The hose supplied with the product is non-toxic food quality. However, a hose is not a permanent connection. It is, therefore, advisable to switch off and close the stopcock valve when the appliance is not in use, e.g. overnight etc.
- If a non-fixed water connection is implemented, use only the water hose provided with the appliance, alternatively, if a fixed water connection is used it must be implemented using a non-detachable water hose.
- The utmost care has been taken in the manufacture and testing of this appliance. Failure to install, maintain and / or operate this machine according to the manufacturer's instructions may result in conditions that can cause injury or damage to property. If in any doubt about the serviceability of the machine always contact the manufacturer or your own supplier for advice.
- This appliance is not intended for use by persons (including children) with reduced physical, sensory, or mental capabilities, or lack of experience and knowledge, unless they have been given supervision or instruction concerning use of the machine by a person responsible for their safety.
- Children should be supervised to ensure that they do not play with the appliance.
- In the event where any wires are damaged, such wires can only be replaced by qualified service technicians.
- CAUTION – Risk of fire and electric shock. Only to be used with manufacturer's specified power cord set.
- This appliance should not be installed in an area where a water jet could be used to clean it.
- Access to the service area of the appliance is restricted to persons having knowledge and practical experience of the appliance and the relevant safety and hygiene requirements.

Information

- Remove all the packaging materials attached to your machine.
- The drain pipe must be connected to and well-fixed to the drain outlet. The machine might discharge a small amount of hot water during use. The drain outlet is strictly prohibited to the direction of possible person, so as to avoid temperature burns.
- Cables, inlet and drain pipes must be correctly and securely connected.
- Do not touch the milk outlet with your hands to avoid high temperature burns. Clean towels must be used for.
- If the machine is out of order, please contact the dealer in time to arrange for maintenance. Unauthorized repairs can damage pipes, leading to the spoilage.

Electrical Installation Procedure

Apply a 16A power plug for installation. When installing the appliance, always observe the local regulations and standards. A suitable mains power supply socket should be available within easy access of the appliance so that it can be disconnected easily after install.

Plumbing Installation Procedure

- Ensure that the equipment is installed according to local plumbing & water regulations.
- Mains water pressure required (limits): 14.5 – 145psi (0.1 – 11 MPa)
- Two point water pipe should be connected to water filter.

Backflow Prevention

This equipment must be installed with adequate backflow protection to comply with all applicable federal, state and local codes.

Information

Hazzards



CAUTION SANITISATION

- Before sanitising the equipment, carefully read the instructions given by the sanitisation product manufacturer and put on all the necessary personal protective equipment (gloves, masks, etc.).
- Ensure that the premises are well ventilated.
- The sanitisation operations should only be carried out by specialised technical



DANGER ELECTRICAL MAINS

- Always disconnect the equipment from the electricity supply before doing any work on it, to prevent damage and health hazards.



CAUTION ELECTRICAL REQUIREMENTS

- The electrical circuit must be correctly earthed and connected by means of a suitable differential safety breaker.



CAUTION ELECTRIC POWER SUPPLY

- Do not connect or disconnect the machine from the socket with wet hands.
- Insert the plug into the wall socket firmly.
- Do not pull on the supply cable in order to remove the plug from the socket.



CAUTION REPLACEMENT OF THE POWER CABLE

- If the power cable is damaged, it must be replaced by the manufacturer or their assistance service or a similarly qualified person in order to prevent any possible risk.



WARNING MALFUNCTION

- If smoke, unusual smells or strange noises are emitted from the machine, disconnect it immediately from the socket and contact the local retailer or technical service assistance.
- Use of the machine in these conditions could cause fires or electric shocks.



ATTENTION

- If the equipment is installed in a kitchen, European Standard EN 60335-2/75 specifies that it must be connected to an equipotential circuit via a wire with section between 2,5 and 10 mm². This connection must be carried-out by a skilled technician, in compliance with the regulation in force in the country of use.



WARNING WATER SUPPLY

- Connect the milk dispenser exclusively to a line of drinkable water supply.



WARNING WATER SUPPLY

- In order to avoid accidental flooding due to losses that may occur on the water supply line, external or internal device it is necessary to install the appropriate anti-flooding valve "WATER BLOCK" (not included in the unit) .

Technical Specification

Model	MILKPAL
Voltage(V)	230V
Frequency(F)	50Hz
Power(P)	3100W
Weight	30KG
Program Combination	16 categories
Maximum Capacity	120 cups/ hour (200 ml per cup)

Counter Cut-out

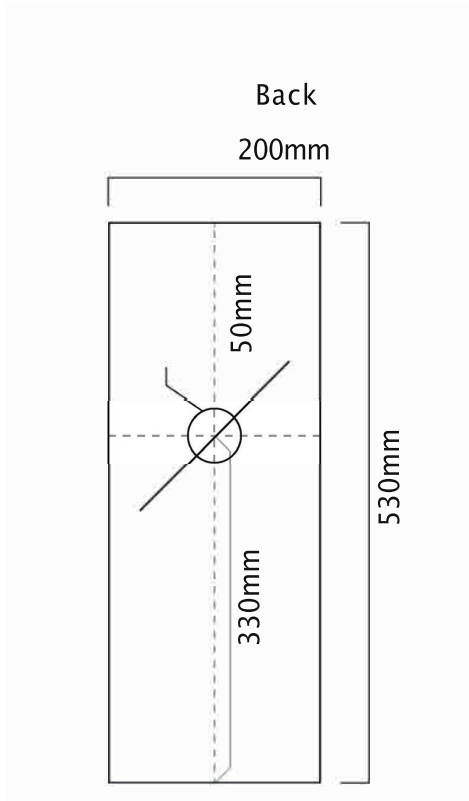

Installation

Preparation

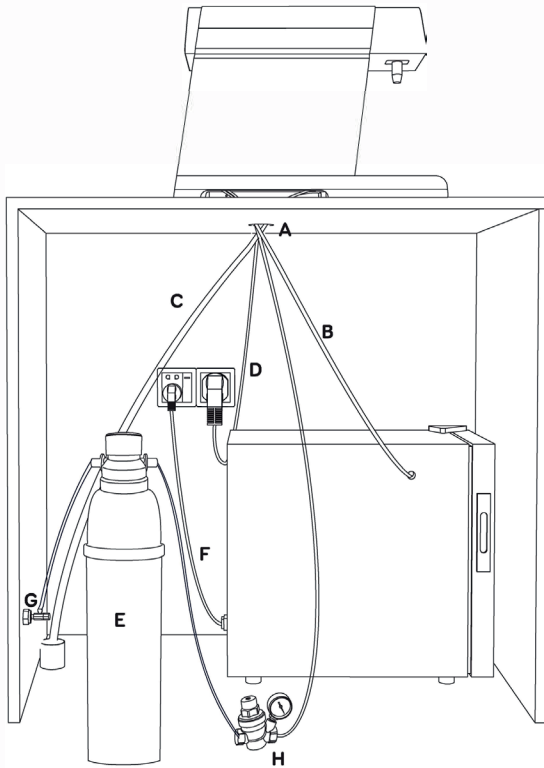

- A: Hole Diameter 50mm
- B: MilkTube (14mm)
- C: Drain Pipe
- D: 4mm² Power Cable
- E: Filter
- F: Milk Fridge Cable
- G: Water Mains Shut Off Valve
- H: Pressure Reducing Valve
Mains water pressure
required (limits): 5-50psi
(35-345kPa)

- Step 1: Put three pipes into the countertop holes. Place the drain hose vertically downward without bending to prevent water accumulation. Do not squeeze three pipes together.
- Step 2: Install the three pipes one by one. The water pipes must be securely fitted and checked for leaks.
- Step 3: Insert the milk tube into the milk container. Drain pipe connects to the drain outlet.
- Step 4: Pay attention to electrical safety. Apply 16A Power Plug or connect to power supply. Power on. The power button is at the bottom right of the machine. (See Components)
- Step 5: The machine enters into the cleaning mode automatically after power on. Wait for the machine to heat up after automatic cleaning mode is completed.

Installation

Connecting to Fridge

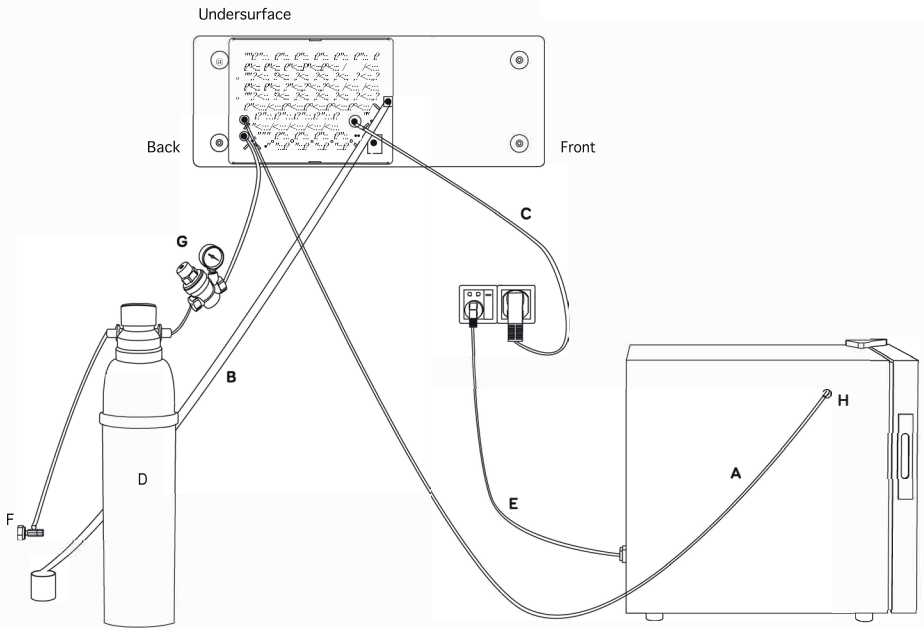

A: MilkTube

B: Drain Pipe

C: 4mm² Power Cable

D: Water Purifier

E: Milk Fridge Cable

F: Mains Water Shut Off Valve

G: Pressure Reducing Valve. Mains water pressure required (limits): 5–50psi (35–345kPa)

H: 20mm hole for milk tube

Installation

Connecting Milk Container

Step1

Prepare milk and open the lid of the milk container

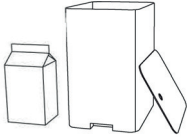

Step2

Pour milk into the milk container

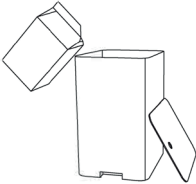

Step3

Cover the milk container



Step4

Open the milk fridge



Step 5

Place the milk container into the milk fridge



Step 6

Put the milk tube into the milk through the hole

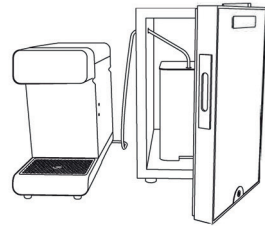

Step 7

Close the fridge door
(Fridge can be placed undercounter or on counter.)

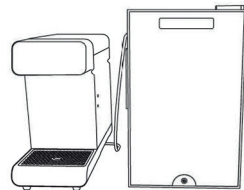

Set Up & Operation

Operating the system for the first time

Remove and discard all labels and packaging materials attached to your machine. Ensure you have removed all parts and accessories from the box before discarding the packaging.

- Check that all electrical and plumbing installation procedures have been carried out.
- Ensure water valve is on.
- Ensure 16A power plug has been fitted.
- Ensure milk line has been inserted into milk container (in fridge).
- Turn on the power switch.
- The system will automatically start 20 second cleaning cycle.
- The system will start to heat up to default temperature.
- Once ready for operation, the system will display the main interface.

1. POWER ON

First, make sure that the cables, water hose and drain hose are correctly and securely connected. Turn on the machine from the bottom right of the machine.



2. CLEANING MODE

The machine starts cleaning automatically for 20 seconds after power on.



3. HEATING

The machine starts to heat up from the original temperature to the set temperature value after self-cleaning.

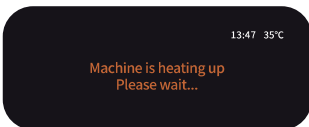

4. USE

After the machine is heated to the set temperature value, it automatically enters into the main interface. You can start using the machine now.

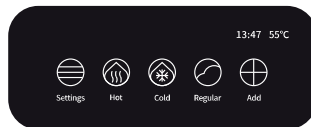

- System is now ready for use.

Set Up & Operation

Main Interface

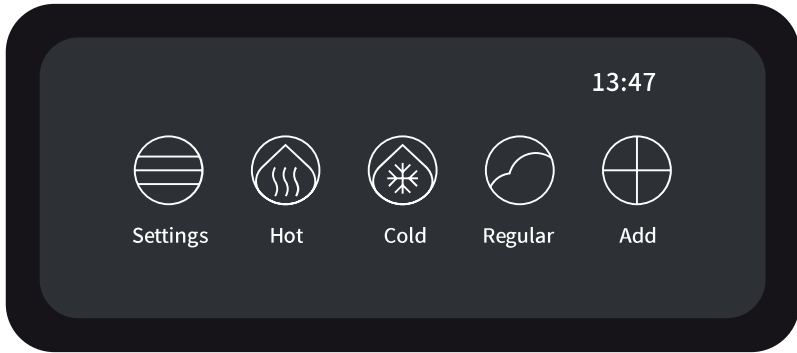

Set Up & Operation

How To Use

Press an icon to dispense pre-set volume and milk froth. Press the corresponding button during the milk froth production to pause manually.



Changing Parameters

Press and hold icon to set the parameter.

Milk Volume: Set the corresponding time of milk froth according to the cup volume, about 15g/second.

- Push slider to the right for higher milk volume
- Push slider to the left for lower milk volume

Air ratio: Indicates the thickness of the milk froth.

- Push slider to the right for thicker milk foam (higher %)
- Push slider to the left for thinner milk foam (lower %)

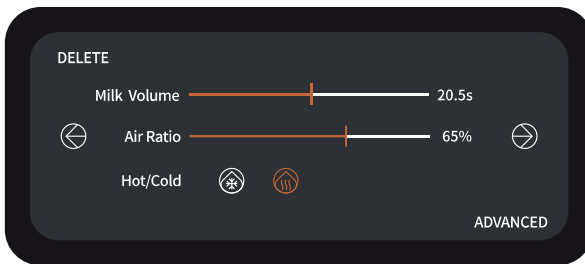

Press the  button to go back to the previous parameter.

Press the  button to enter into the confirmation page.

Set Up & Operation

Confirmation Page

Press  to replace the existing parameter.

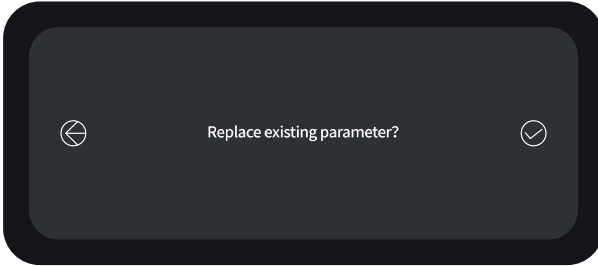

Menu Icon Removal

Press and hold icon to set the parameter. Press the 'delete' button from the left-hand corner to enter into the 'delete confirmation' page.

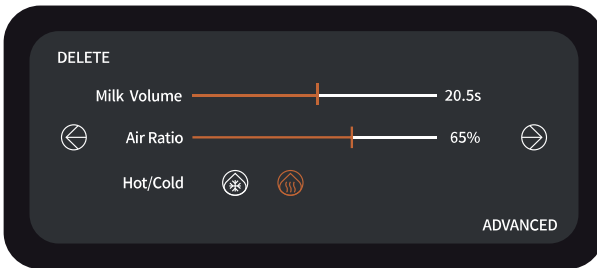

Confirmation Page

Press  button to return to the previous page. Press  button to confirm your selection.

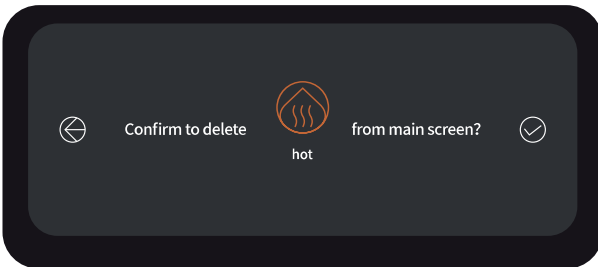

Set Up & Operation

Adding a New Recipe

Press  to add new recipe.

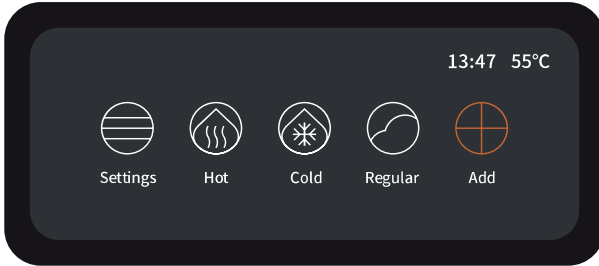

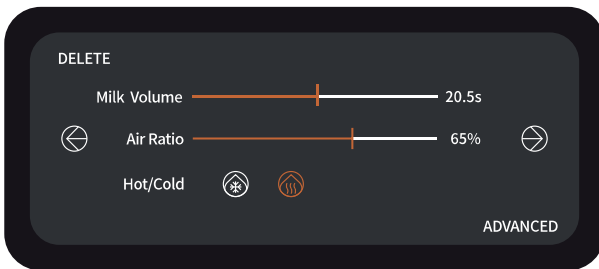

Milk Froth Parameters Adjustment Page

Set your milk volume and air ratio (see page 12). Choose either hot or cold. Then press the  button to the next page.



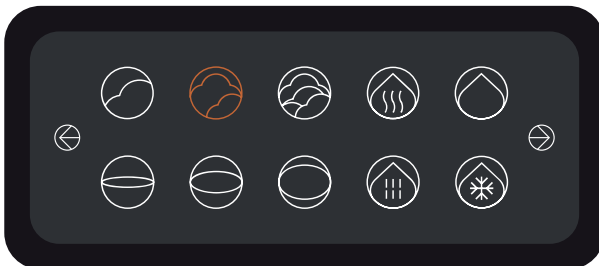

New Recipe Icon Selection

Select your choice of icon . Press  to cancel your choice and return to the previous page. Press  to enter into the new recipe icon selection page.



Set Up & Operation

Choice of Beverage Name

Select your choice. Press  to cancel your choice and return to the previous page. Press  to enter into the confirmation page.

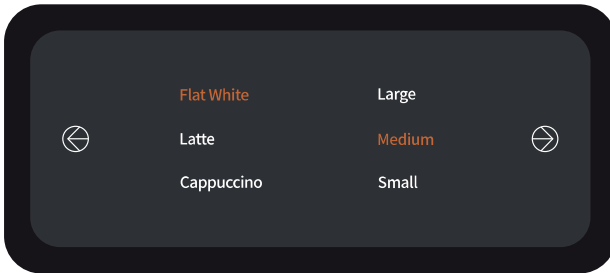

Confirmation Page

Press  to return to the previous page. Press  to confirm your selection.

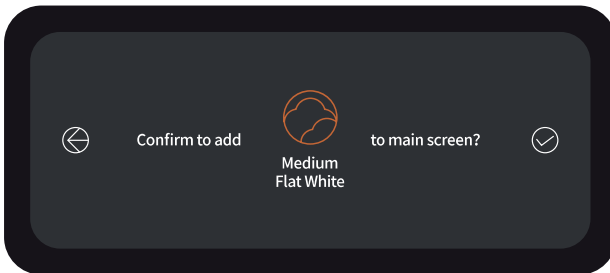

New Recipe Icon has successfully added at the Main Interface.

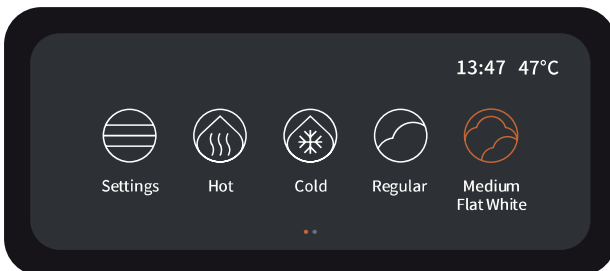

Set Up & Operation

Setting Temperature

Select the 'Settings' button, click 'Temperature' to enter into the next interface.

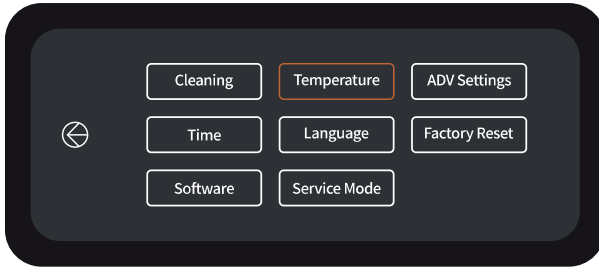

Temperature Adjustment

Click or drag the progress bar to the desired temperature value.

Click the  button to confirm the setting.

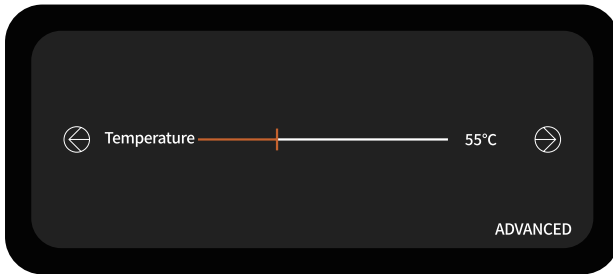

Confirmation Page

Press  to confirm the setting.

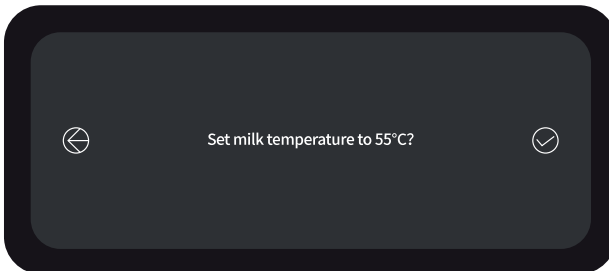

Set Up & Operation

Temperature Indication

Indicate the set temperature value on upper right corner of the LCD Screen.

Temperature Setting Min: 40° - Max 80°

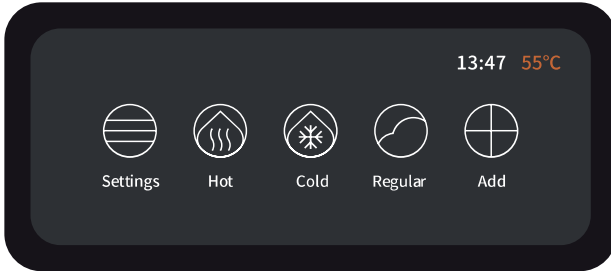

Advanced Settings

Settings

Click the 'Settings' button.

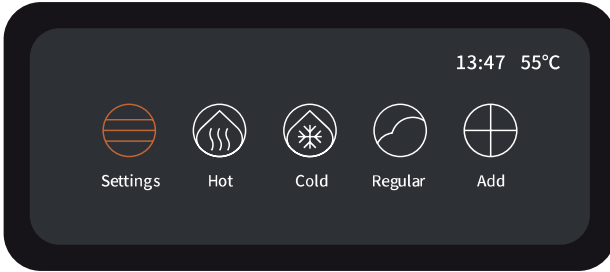

ADV Settings

Click the 'ADV Settings' to enter into the password page.

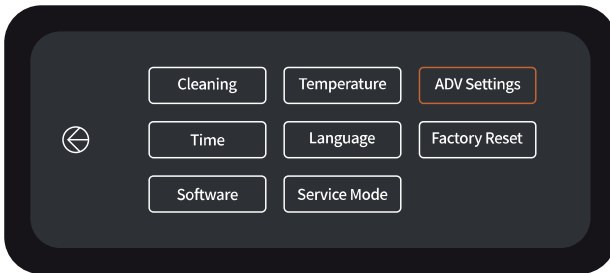

Password Settings

Enter the password: the password is the time displaced on the machine.

Example: the machine time is 1347 as shown in [Figure 2](#). Enter the password with 1347 .

Click the  button to confirm the password.

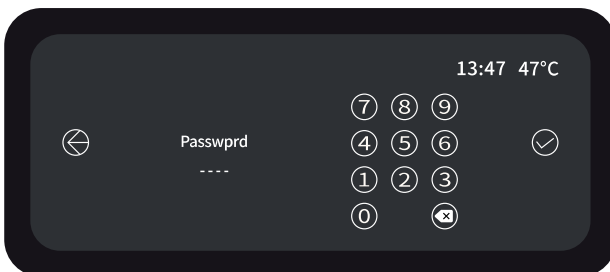

(Figure 2)

Advanced Settings

Adjustment Page

Select the option that needs to be modified. Click or drag the required parameter value.

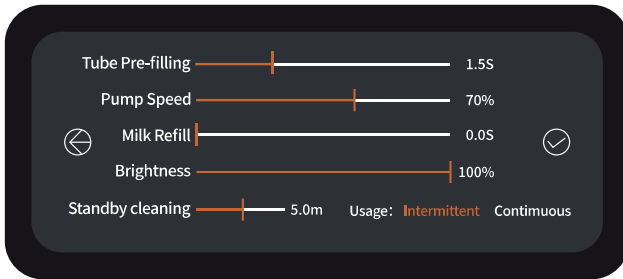

Tube Pre-Filling

Adjust the time according to the length of the milk tube.

Pump Speed

Adjust the speed of motor.

Brightness

Adjust the brightness of the display screen.

Standby Cleaning

If the machine is unused all pipes will be cleaned according to the set time.

Advanced Setting (From Recipe Page)

In the chosen recipe page, select “Advanced”

Enter the password. Password should be the time displayed on the screen. For example, if current time is 13.37, password is 1337.

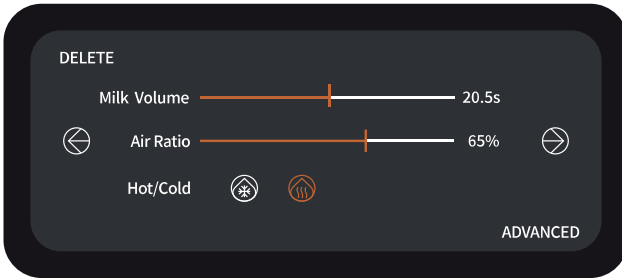

Pre-Fill

Milk will be pushed into milk pipe after a flush or when first powered on.

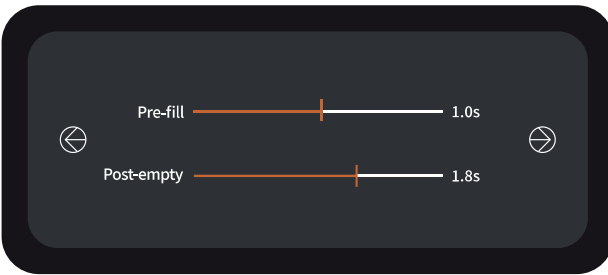

Post-Empty

After machine is unused for 5-10 minutes, milk will be pushed back into milk container and a short water flush will be dispensed.

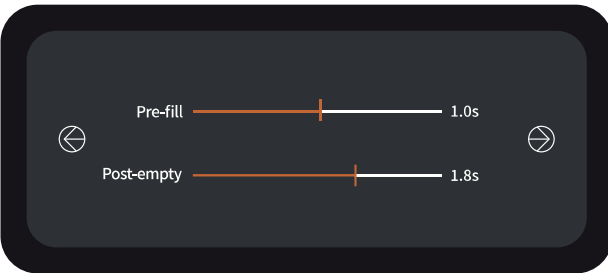

Cleaning

Cleaning Settings

Click 'Settings' button, then click 'Cleaning' button.

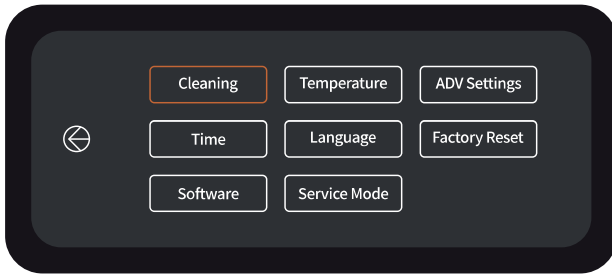

Setting Page

Click the  button to enter into the password page.

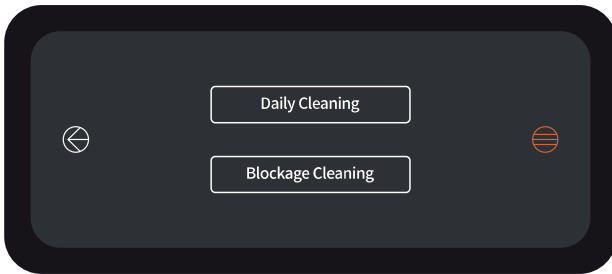

Password Settings

Enter the password: the password is the time displaced on the machine. Example: the machine time is 1347 as shown in [Figure 3](#). Enter the password with 1347. Click the  button to confirm the password.

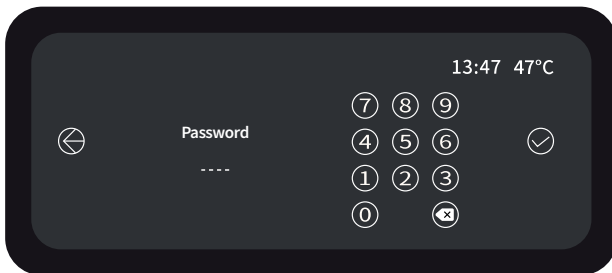

(Figure 3)

Cleaning

Cleaning Settings

Click Cleaning Parameters button.

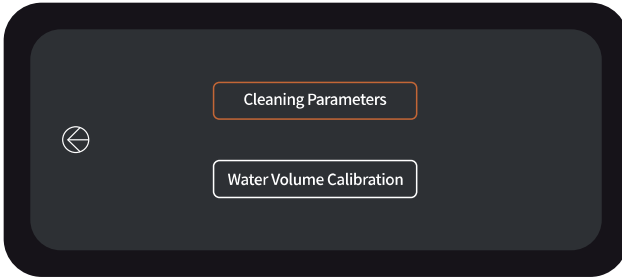

Adjustment Page

Click or drag the required parameter value.

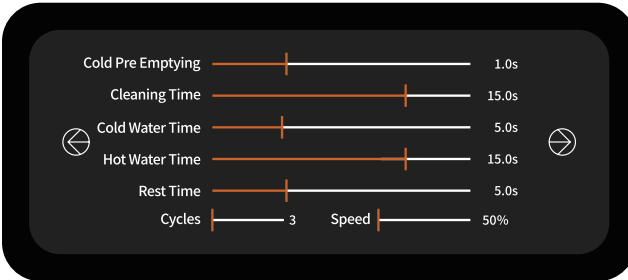

Cold Pre-Emptying

Amount of time to push milk from milk tube back to the milk container (depends on length of milk tube.)

Cleaning Time

Pause time between water dispensed to dissolve/dilute cleaning tablets or liquid and cleaning cycle to begin.

Cold Water Time

Amount of cold water used to dissolve/dilute cleaning tablets or liquid.

Hot Water Time

Amount of hot water used to dissolve/dilute cleaning tablets or liquid.

Rest Time

Amount of time cleaning liquid stays in pipes during cleaning.

Cycles

Frequency of cleaning cycles.

Speed

Pump speed during cleaning process.

Cleaning

Easy Cleaning

After the machine has not been used for 3 consecutive minutes, it will automatically enter into the 'easy-automatic cleaning program', which lasts for around 15 seconds. During "easy-automatic cleaning" the MilkPal will internally flush milk from the lines back into the milk vessel. This is called "pre-fill" in Advanced Settings.

Standby Cleaning (Can be shut down)

After the machine has not been used for 6 consecutive minutes, it will automatically enter into the "standard-automatic cleaning program", which lasts for around 25 seconds. (The parameter of Standby Cleaning can be set or set up from 5 minutes to maximum 10 minutes under the ADV Setting).

During "standby cleaning" MilkPal will preform a two-step process to clean the system:

Step 1 = Pre-fill, it will flush milk from the lines back into the milk vessel.

Step 2 = Post empty, water will be flushed through the lines and released from the dispense point

Daily Cleaning

*Daily cleaning procedure will use one of the recommended cleanings solutions. The process will take approximately 30 minutes. We recommend operate this type of cleaning at the end of the day. (Specific parameter can be set under ADV Setting)

Recommended Cleaning Settings:

Users can choose from the below cleaning solutions:

1 x MilkPal tablet for daily use

30 ml Urnex Rinza liquid for daily use

1 x Cafetto MFC Blue tablet for daily use and 1 x Cafetto MFC Red tablet for weekly use

Wipe the screen daily with a dry microfibre cloth. Do not use cleaning agents.

Daily Cleaning

1. Go to the 'Setting' page Click 'Cleaning' button then 'Daily Cleaning'.

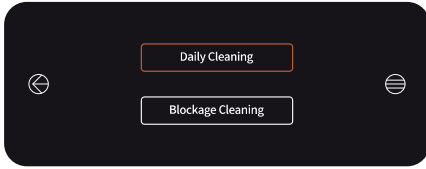

2. The milk outlet will be flushed automatically.

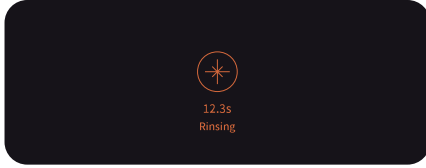

3. Remove milk tube from milk container and connect its tip to the drip tray. Then click  button to the next page.

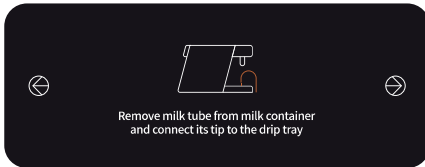

4. The milk tube will be emptied. Please wait for the countdown timer to finish.

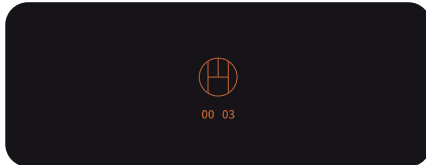

5. Empty the milk pitcher. Click  button to the next page. Place 1 x cleaning tablet or 30ml cleaning liquid and milk tube tip into the empty milk pitcher. If using tablet, split or break up before adding to milk pitcher.

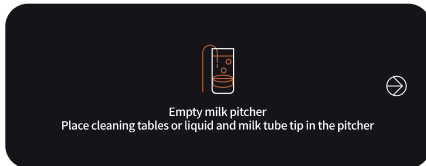

Daily Cleaning

6. Place milk pitcher below the milk nozzle. Press the  button to start cleaning.



7. The machine cools down to 50°C. Please wait until it ends.

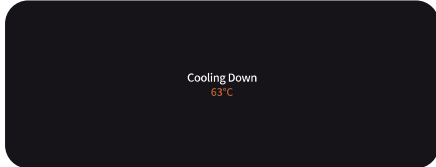

8. Please wait for the countdown time to finish.

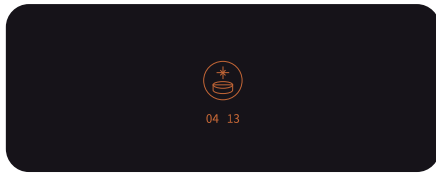

9. Cleaning is completed. Please turn off the machine.

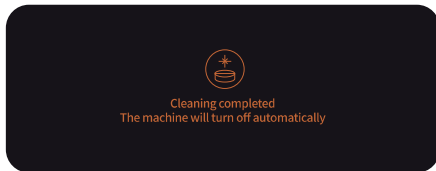

10. Wipe the screen daily with a dry microfibre cloth. Do not use cleaning agents.

Blockage Cleaning

Go to the 'Setting' page and Click 'Cleaning' button then 'blockage cleaning'.

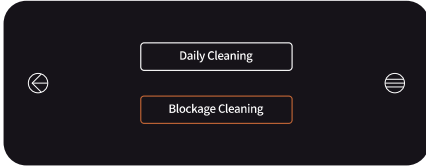

2. Remove the milk tube from the tank and place it in the sink.

Use a container of clean water to immerse the milk nozzle. Click  button to the next page.

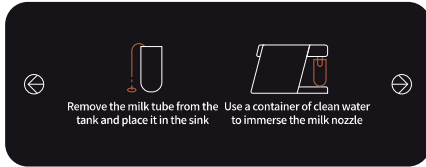

3. Press the  button to start cleaning.

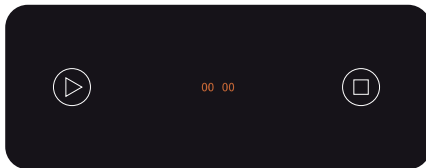

4. The machine starts cleaning. The cleaning time is set for 20 seconds.

Wait until the cleaning comes to an end.

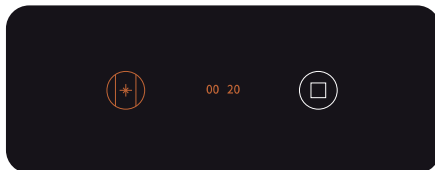

5. The cleaning process is finished if the screen displays 00:00 as follows. Click  button for the next

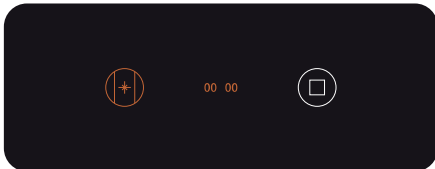

6. Click the  button to finish and return.

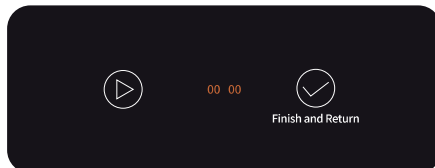

Troubleshooting

Debugging the Milk Froth Production

Press the 'Advanced' button to adjust the parameter of milk froth production.



Water Dispensing Pre-Post Output

Increase the time of pre-fill gradually if water comes out from the front-end during the production process. Decrease the time of post-empty gradually if water comes out at the back end during the production process. Press  button to confirm the selection and observe if there is any water comes out. Observe until no milk wasted.

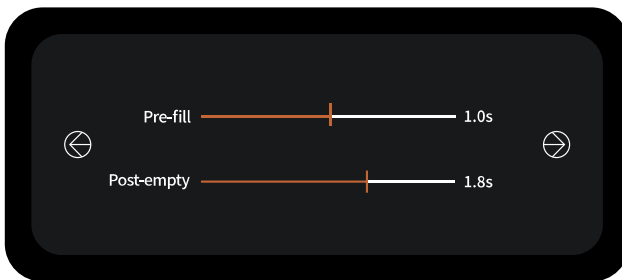

Confirmation Page

Select your option. Press  button to return to the previous page.

Press  button to confirm your selection.

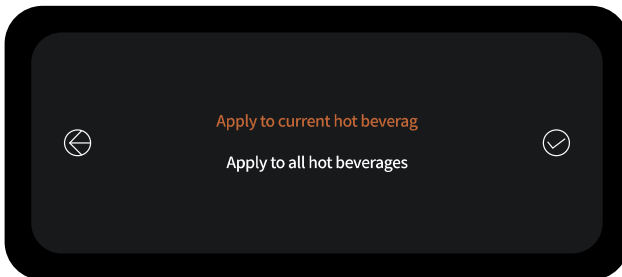

Troubleshooting

Tube Pre-Filling

There should be no milk wasted from the drain outlet, and no water dispensed from the milk outlet during use.

If an exception occurs after the first start-up and standard-automatic cleaning, adjust the tube pre-filling time in Advanced Settings.

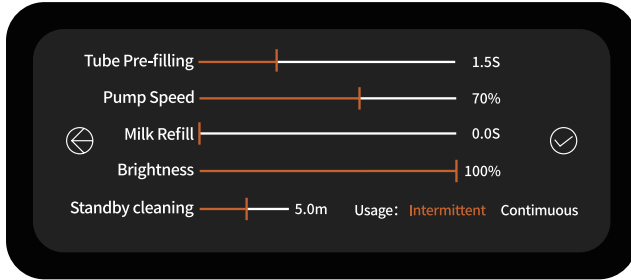

Cold Pre-Emptying

After machine is unused for 5-10 minutes, milk will be pushed back to the milk container.

The time for cold pre-emptying is adjusted according to the length of the milk tube and the inlet pressure.

If the set time is too long, pure water will enter into the milk container. In this case, decrease the time of pre-emptying.

If the set time is too short, milk residue will appear in the milk tube. In this case, increase the time of pre-emptying.

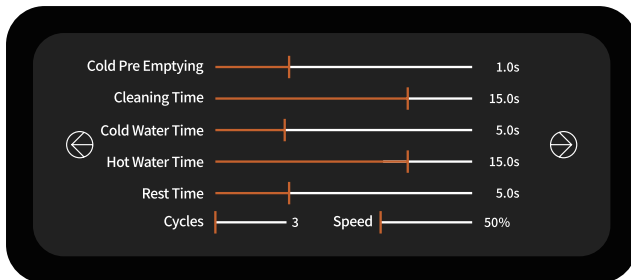

Notes

Notes

Notes

Contact Details

Marco Beverage Systems Limited.
74 Heather Road,
Sandyford Industrial Estate,
Dublin 18
Tel: +353 (0)1 295 2674
Fax: +353 (0)1 295 3715
email: sales@marco.ie
www.marco beveragesystems.com

